

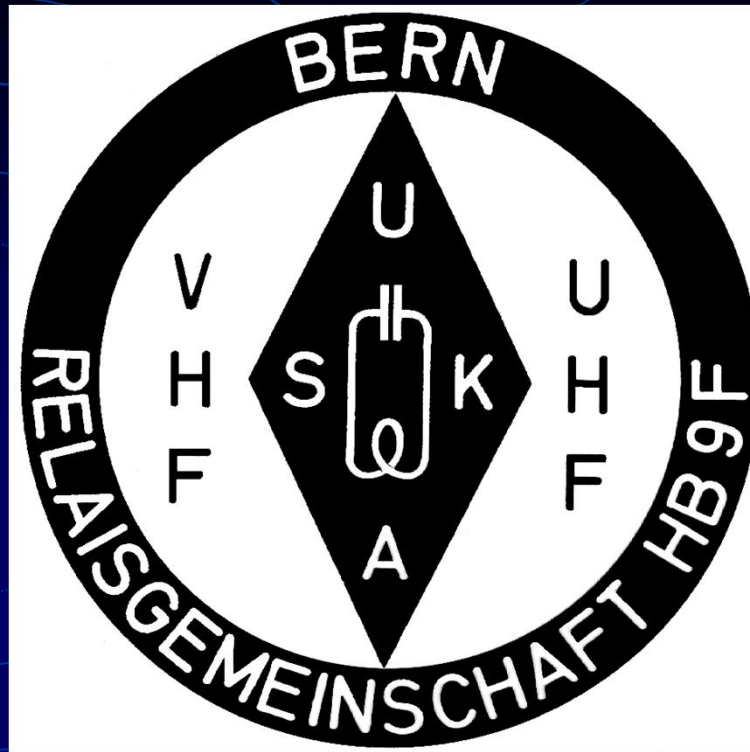

Relaisgemeinschaft HB9F Bern

Schilthorn, die Brücke zwischen
West und Ost



Wer sind wir?

Relais + Baken im 2. Quartal 2014

HB9F

Magglingen
145.6500 MHz

HB9F

Interlaken
438.9750 MHz

HB9F

Niesen
439.0500 MHz

HB9F

Bern / Stadt
145.6875 MHz
438.9250 MHz

HB9F

Brienz
432.8250 MHz

HB9F

Jungfrauoch
432.4320 MHz
1258.9000 MHz

HB9F

Schilthorn
51.8500 MHz
145.7000 MHz
439.4750 MHz
438.2125 MHz
D-ATV 13/23 cm

HB9F + HB9BO

Brienzer Rothorn
145.6125 MHz
439.5250 MHz
439.5000 MHz
1258.8000 MHz
1259.0250 MHz

FM-Phonie
FM-Phonie + Echolink
DMR-Phonie
D-Star Voice mit Gateway
Mixbetrieb D-Star / APCO25
D-Star Data mit Gateway
BAKE-Telegraphie
D-ATV
Mix-Betrieb FM / DMR
Mix-Betrieb FM / APCO25

Schilthorn „Piz Gloria 007“



Im Geheimdienst Ihrer Majestät



D-ATV Repeater **Schilthorn**

Tx 2350 MHz (DVB-S), Rx 1280 MHz (DVB-S + FM)

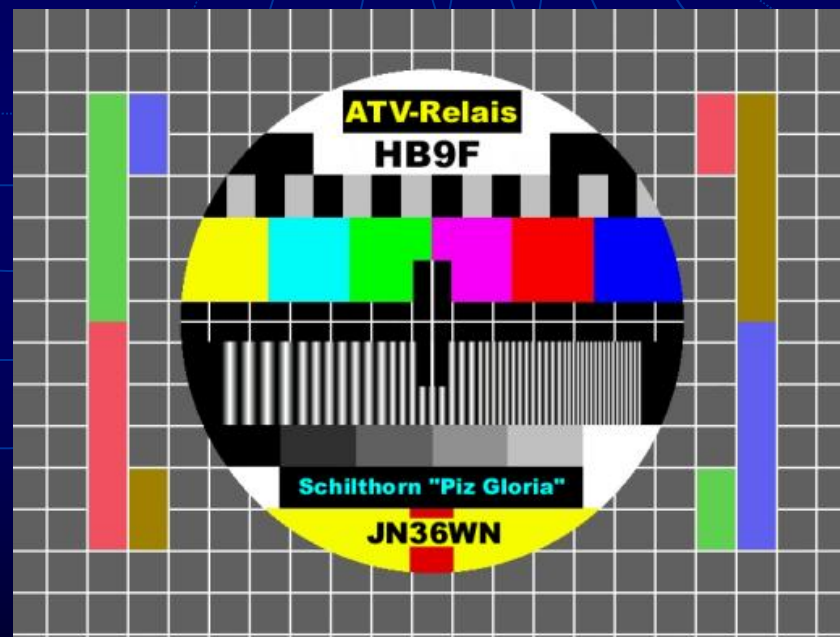

D-ATV Repeater **Schilthorn**

Neubau der 13cm + 23cm Antennen



D-ATV Repeater **Schilthorn**

Empfangsantenne 23cm / 8 Schlitzte, einseitig



alter Mast Schilthorn



Seitenansicht Schilthorn



neue Antennenanlage **Schilthorn**



neue Antennenanlage Schilthorn



27.6.2014/HB9MHS

Relaisgemeinschaft HB9F / Ham Radio

12

Die Antennenanlage im Winter



Montage einer Antenne am Seil





HB9F im Netz

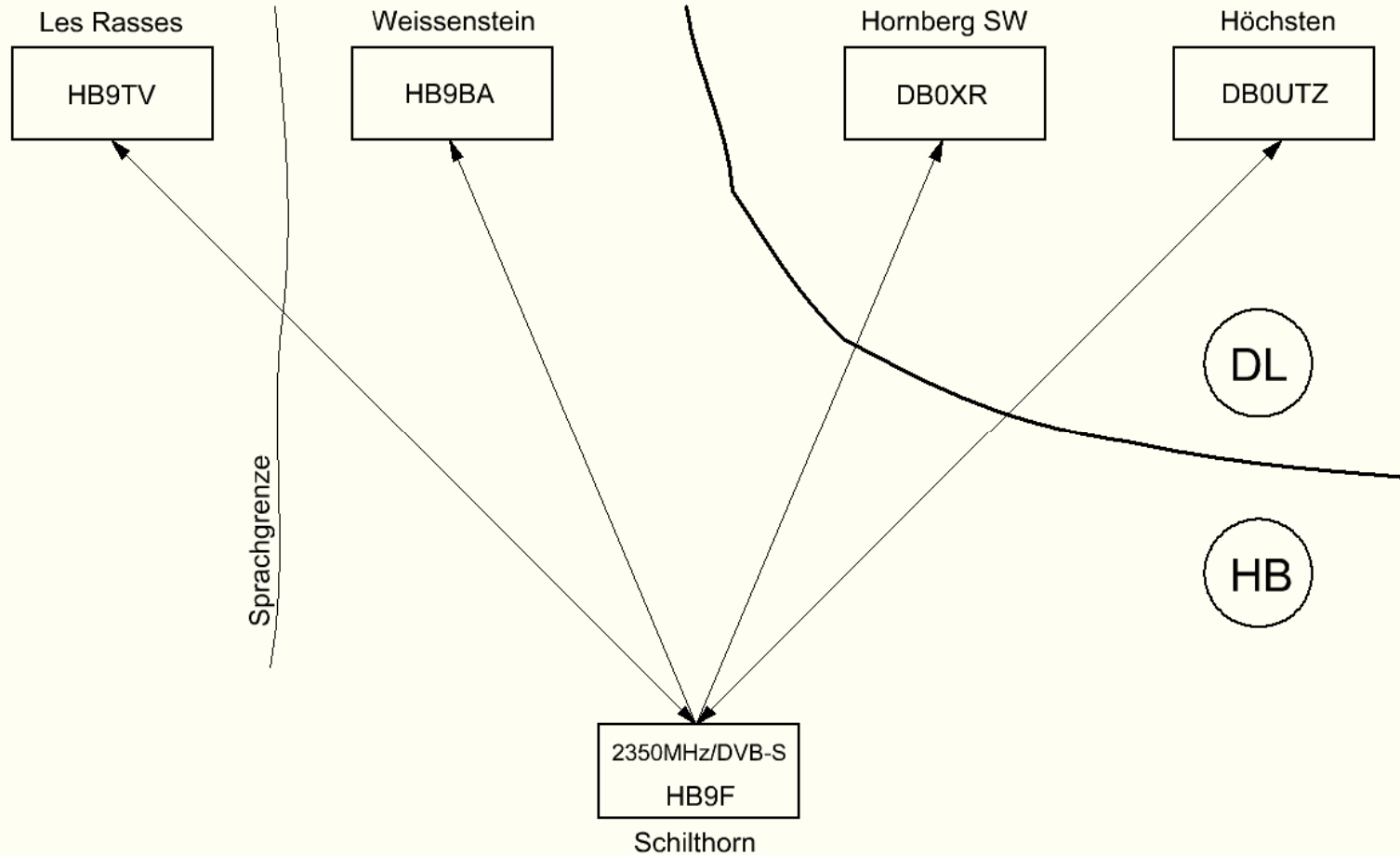

Auf der Karte

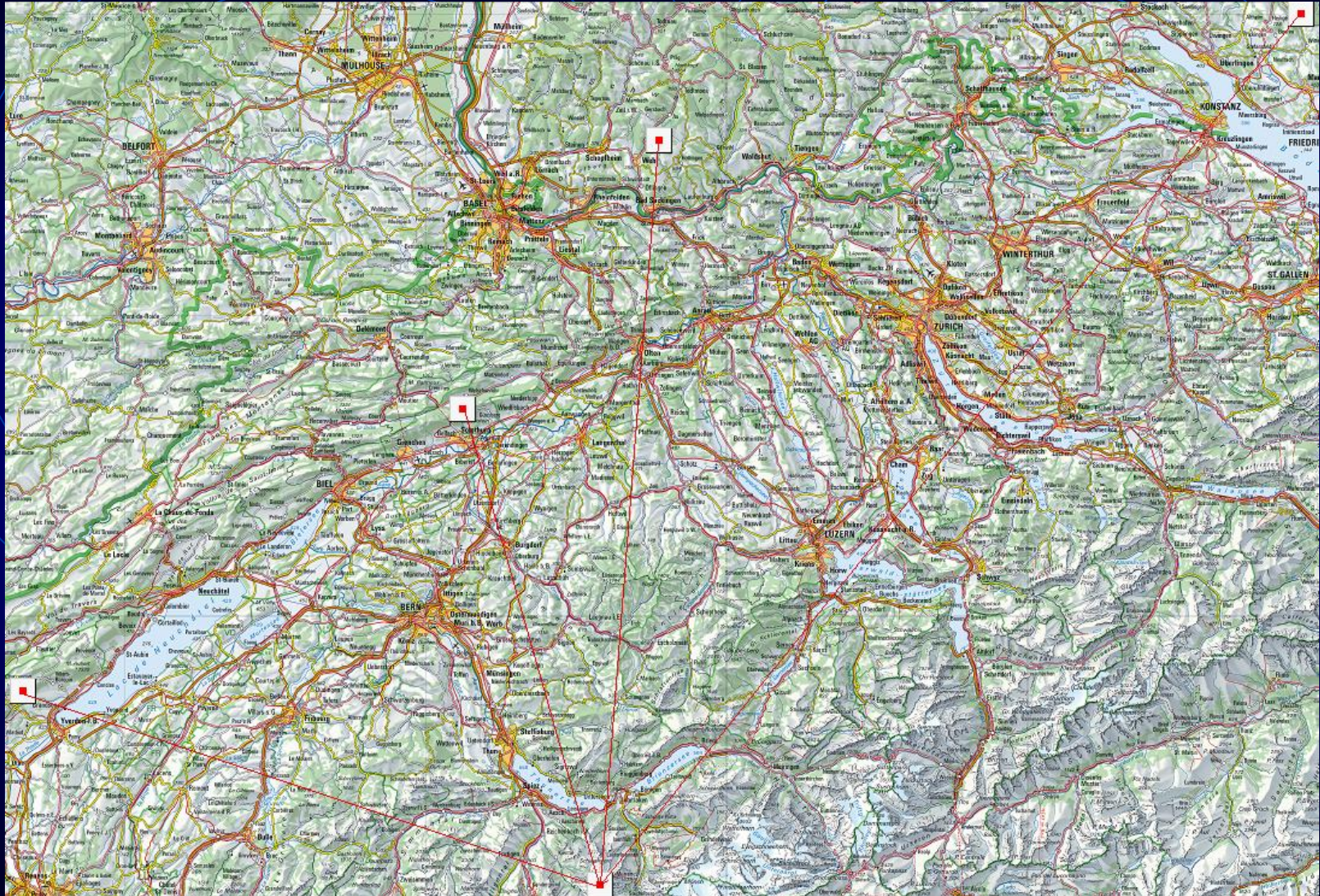

Transportstreams Schilthorn

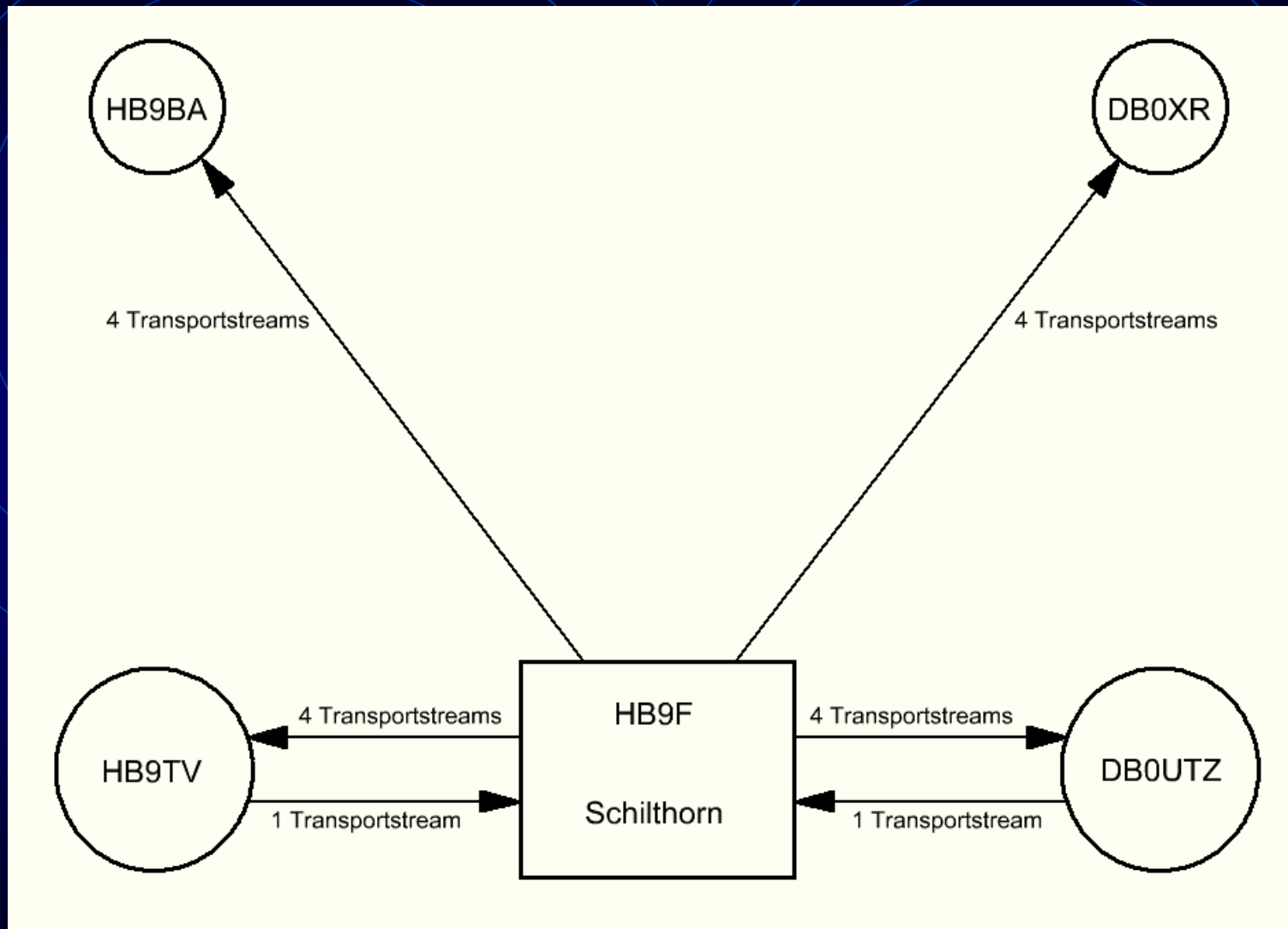

Blockschema Repeater Schilthorn

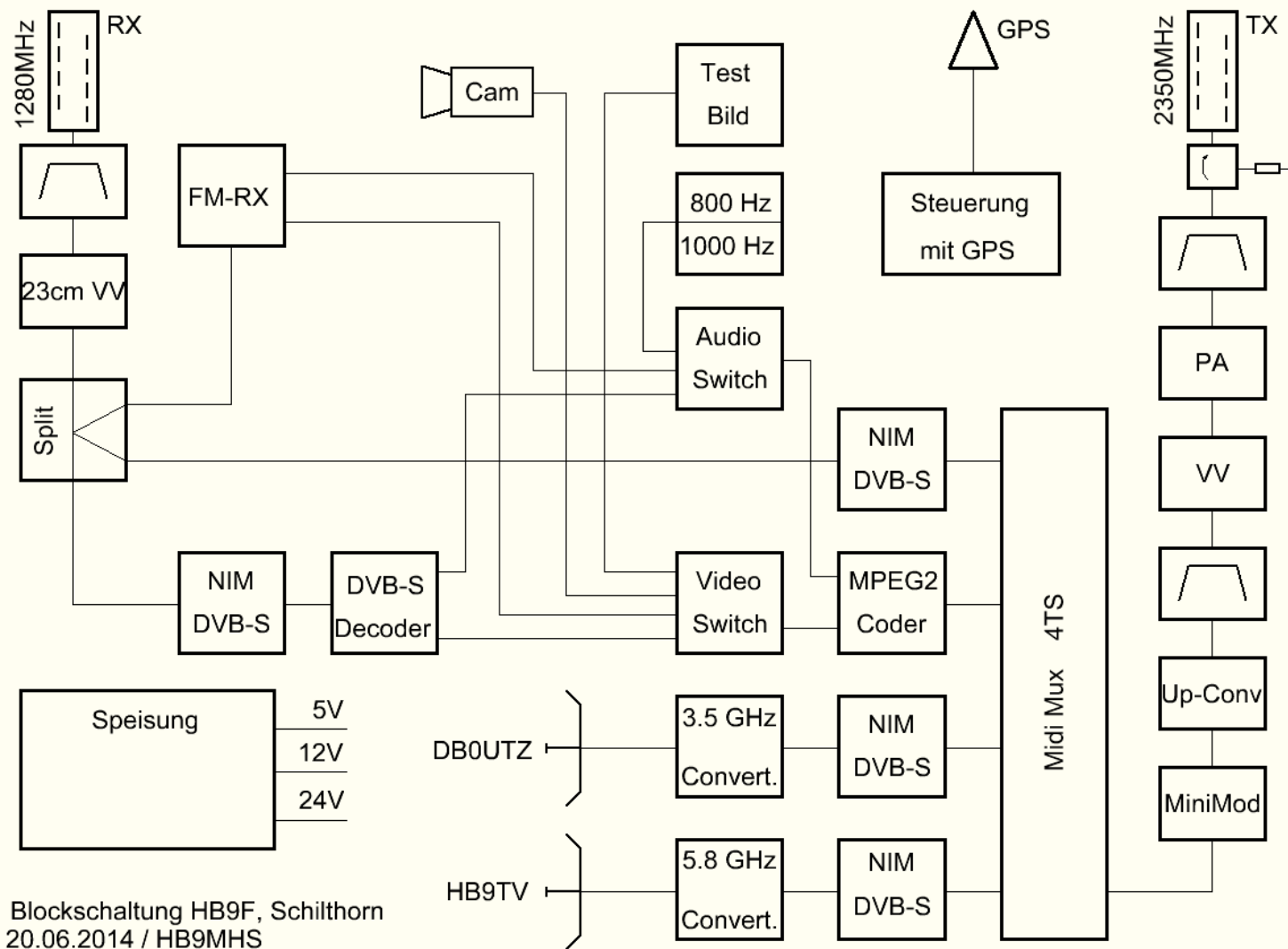

Blockschaltung HB9F, Schilthorn
20.06.2014 / HB9MHS

Steuerung und Aufbereitung

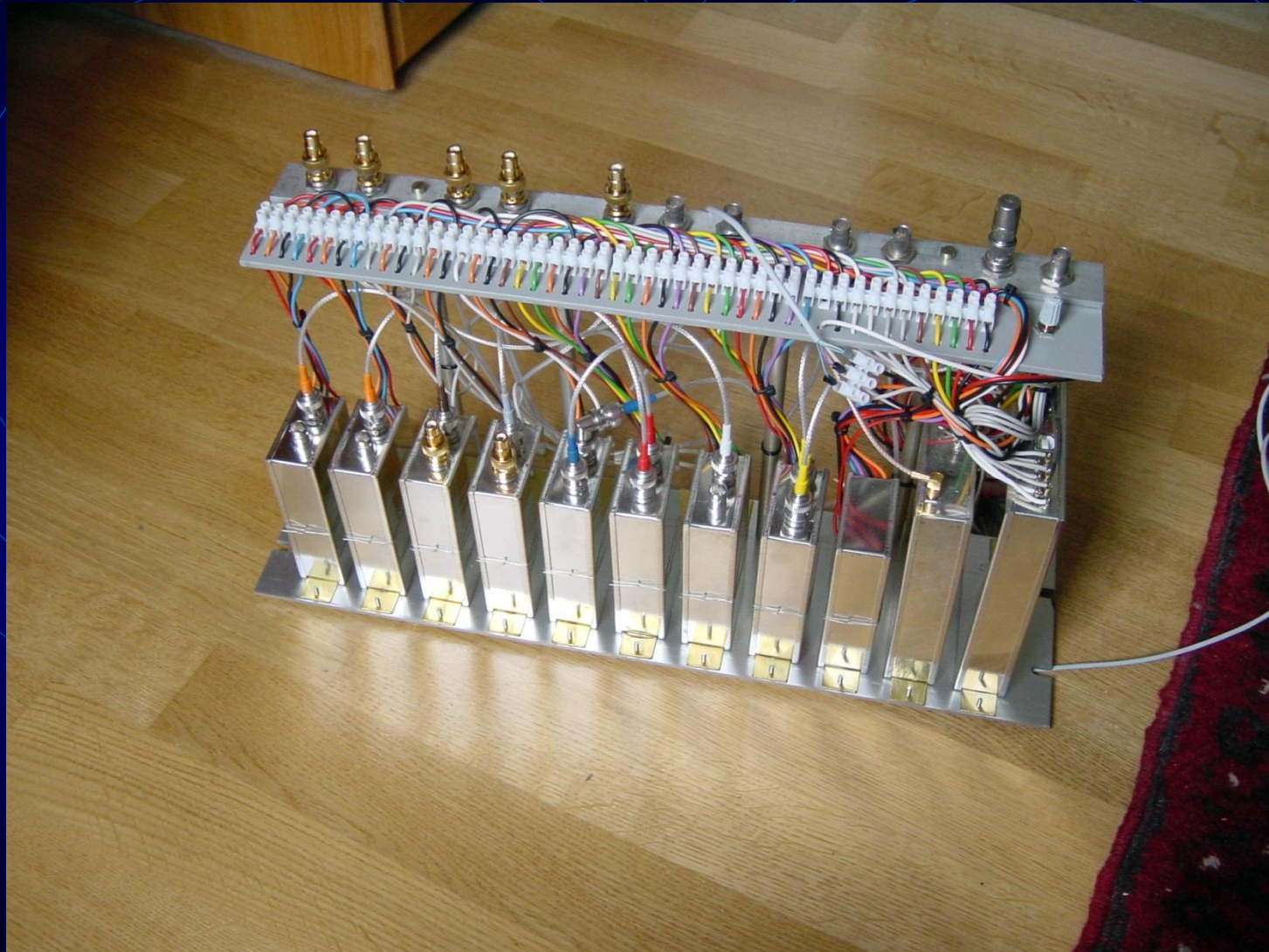

Aufbau der Schaltungen

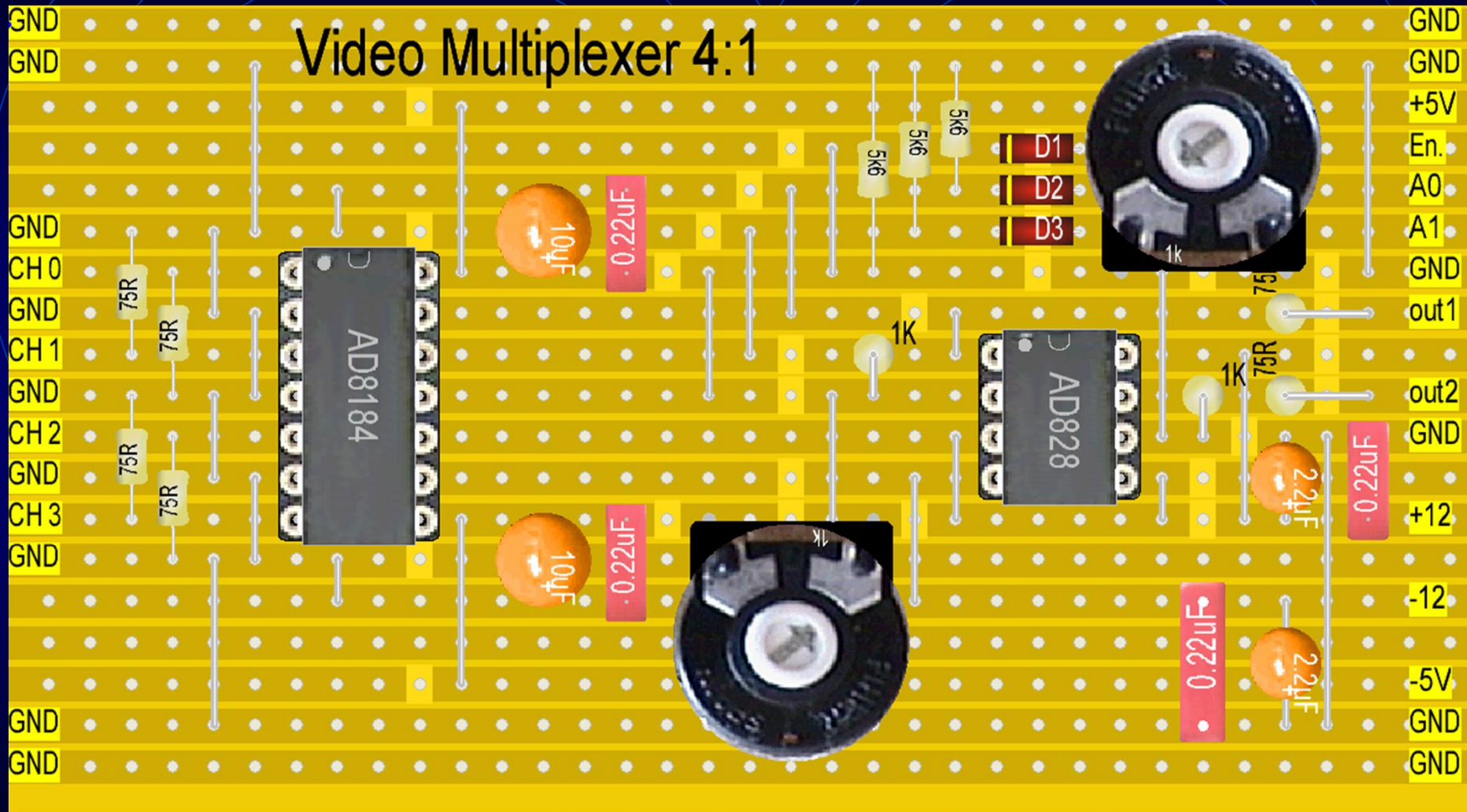

Prototyp Video-Multiplexer

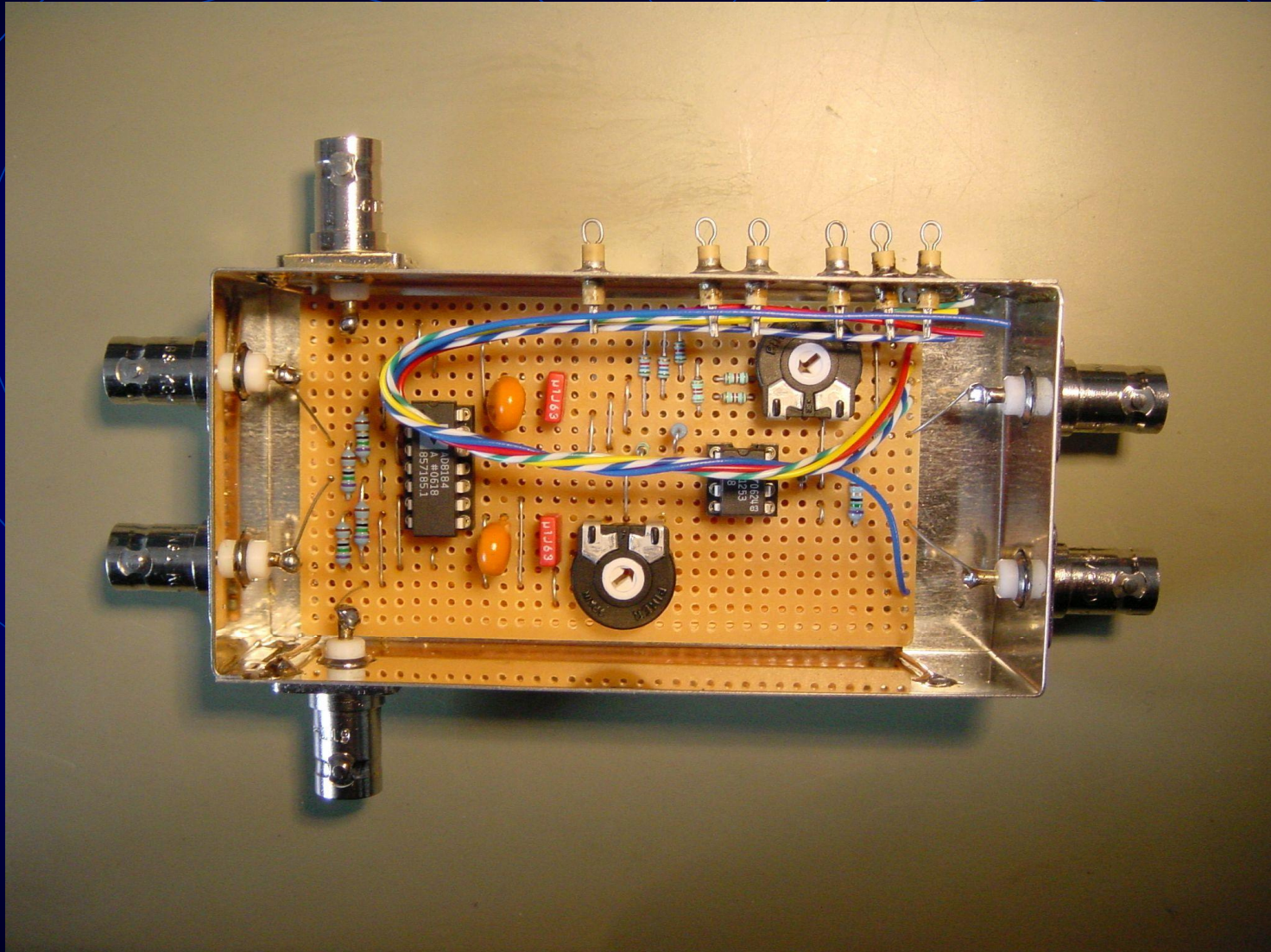

Mux und Co.

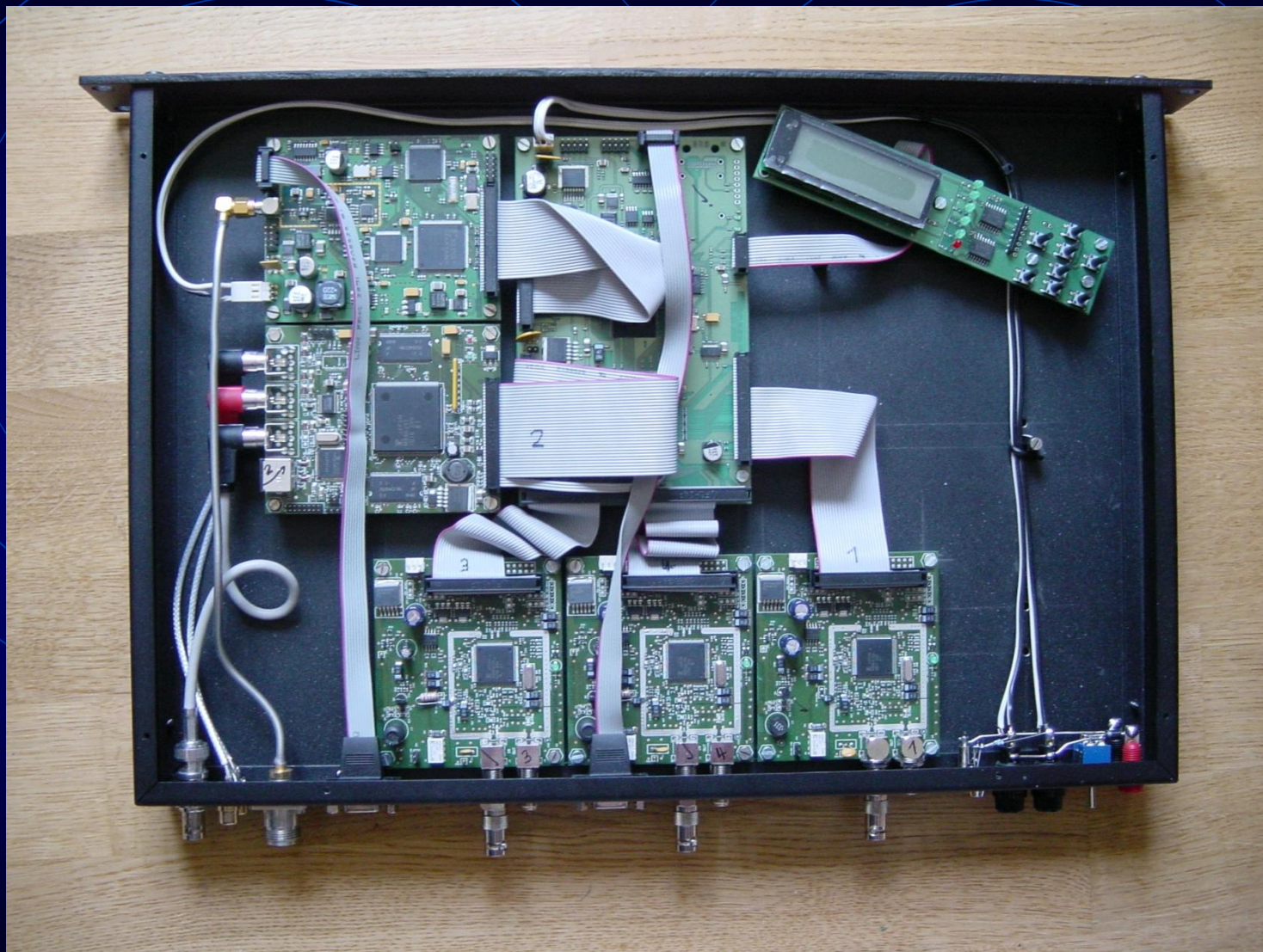

Up-Converter Schilthorn

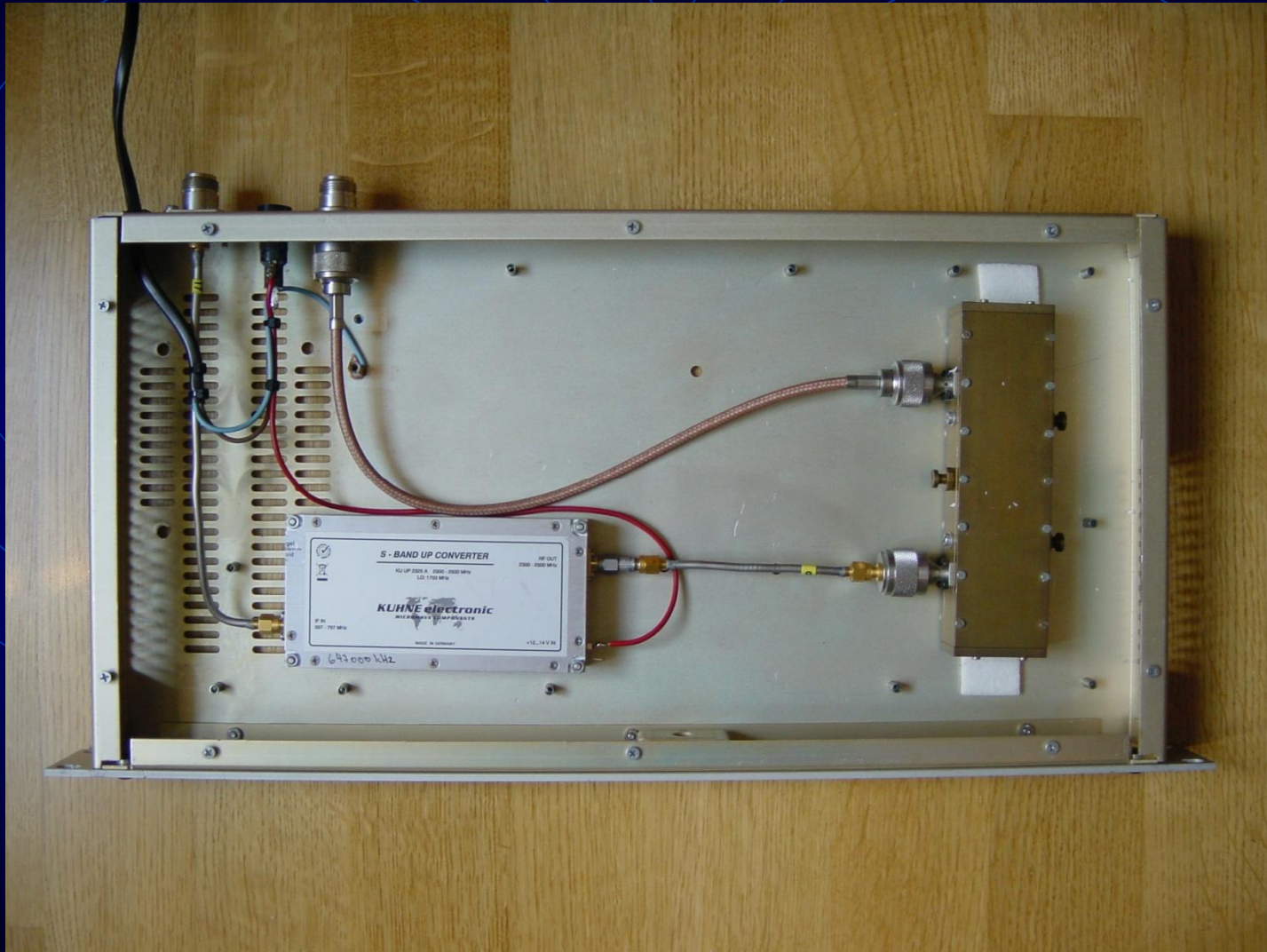

Spektrum am Senderausgang

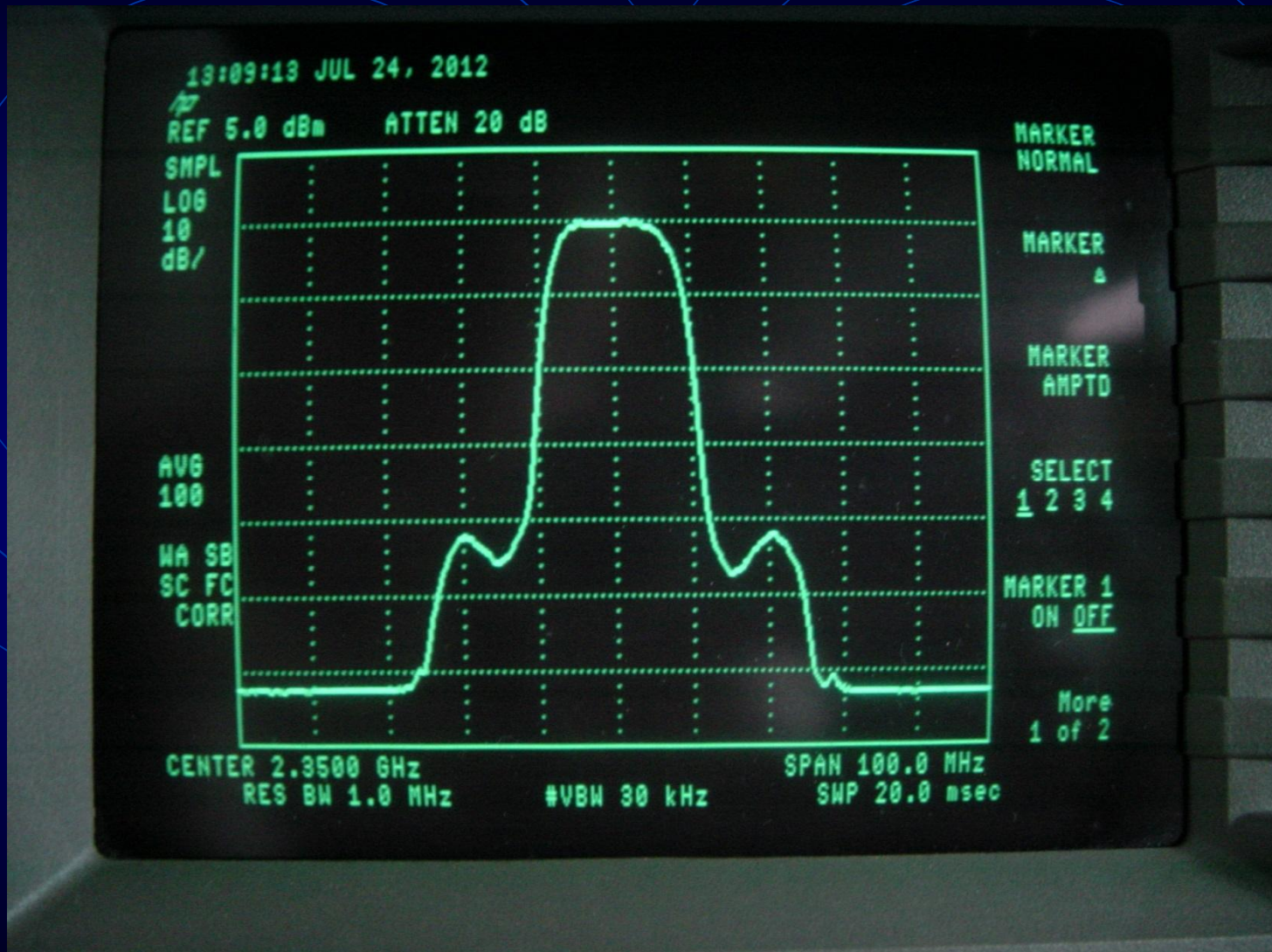

Der 1. Benutzer der Anlage



Utz Kehrer, DF2SU



Testarbeiten zu DBOUTZ



Testarbeiten zu HB9TV



Unsere Homepage

relais-hb9f.ch

ENDE

**Ich danke für die
Aufmerksamkeit!**